

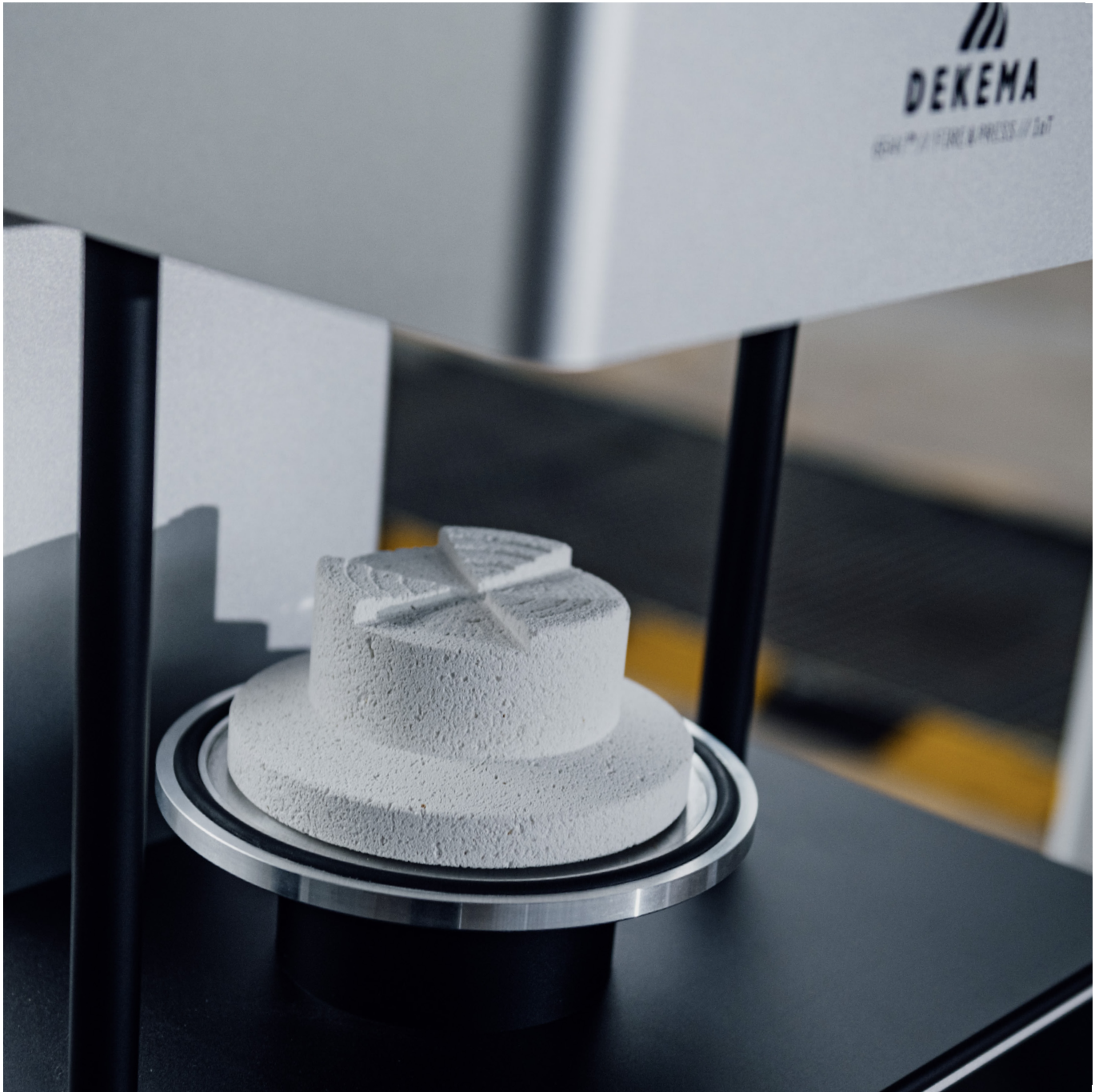

PRODUCT CATALOG // FIRE & PRESS // 2025



WHERE QUALITY FEELS AT HOME. The home of our DEKEMA furnaces.

For over 50 years, DEKEMA has been a benchmark for highest quality, precision and reliability – Made in Germany.

But our furnaces are far more than just technological masterpieces. They are faithful companions that help dental technicians all over the world to practise their art at the highest level. They make perfection possible, express passion and help to give the most valuable thing there is.

the most valuable thing there is: Our responsibility does not end with the purchase: we are there – personally, directly, on site. With our service, we not only bring technology to laboratories, but also trust and safety. Our service technicians come directly to the laboratory, providing expertise, support and customised solutions – exactly when it matters.

Individual support, genuine proximity, active partnership – that's what DEKEMA is all about. Because it takes more than just a furnace.

Dr Stephan Miller
CEO



FROM FREILASSING OUT INTO THE WORLD.

DEKEMA. Content.

DEKEMA. Passion.	6
DEKEMA. Claim.	7
DEKEMA. Manufacture.	8
DEKEMA. Sustainability.	10
DEKEMA. Equipment.	11
DEKEMA. Highlights.	12
DEKEMA. Circle.	13
AUSTROMAT™ 220 G2 – firing	14
DEKEMA. Accessories – AUSTROMAT™ 220 G2	18
Series <i>i</i> G2 – reduced to the maximum.	20
AUSTROMAT™ 624/624 ⁱ ™ G2 – firing	22
DEKEMA. Accessories – AUSTROMAT™ 624 ⁱ ™ G2	26
AUSTROMAT™ 654 ⁱ ™ G2 – firing and pressing	28
DEKEMA. Accessories – AUSTROMAT™ 654 ⁱ ™ G2	32
Back to basic – the Series 6.	36
DEKEMA. Vacuum.	38
DEKEMA. Device equipment – Comparison of all firing and pressing furnaces	40
DEKEMA. Software features – Comparison of all firing and pressing furnaces	42
DEKEMA. Accessories – Comparison of all firing and pressing furnaces	44



Naoki Aiba, oral design Center Monterey

DEKEMA. Passion.

It's our ambition to further refine our already matchless dental ceramic furnaces. We have decades of experience with every component of our products. Dental ceramic furnaces by DEKEMA are made exclusively of high-quality materials and are superior in their class. As a fully independent German manufacturer, we top the highest quality expectations.

What are your benefits?

The best performance, reproducibility and quality are embedded in incredible ease of use. In short: top-class aesthetics.

**„YOU HAVE TO DELIVER
PERFECT WORK?
DAY AFTER DAY?
YOU CANNOT AFFORD
A DIFFERENT PRODUCT.“**

Experience the world of DEKEMA in your lab every single day. We offer the highest level of service. Fast support matters of course, as is the rapid and straightforward provision of replacement equipment and support for new developments. That's what we all stand for, DEKEMA and our worldwide partners.

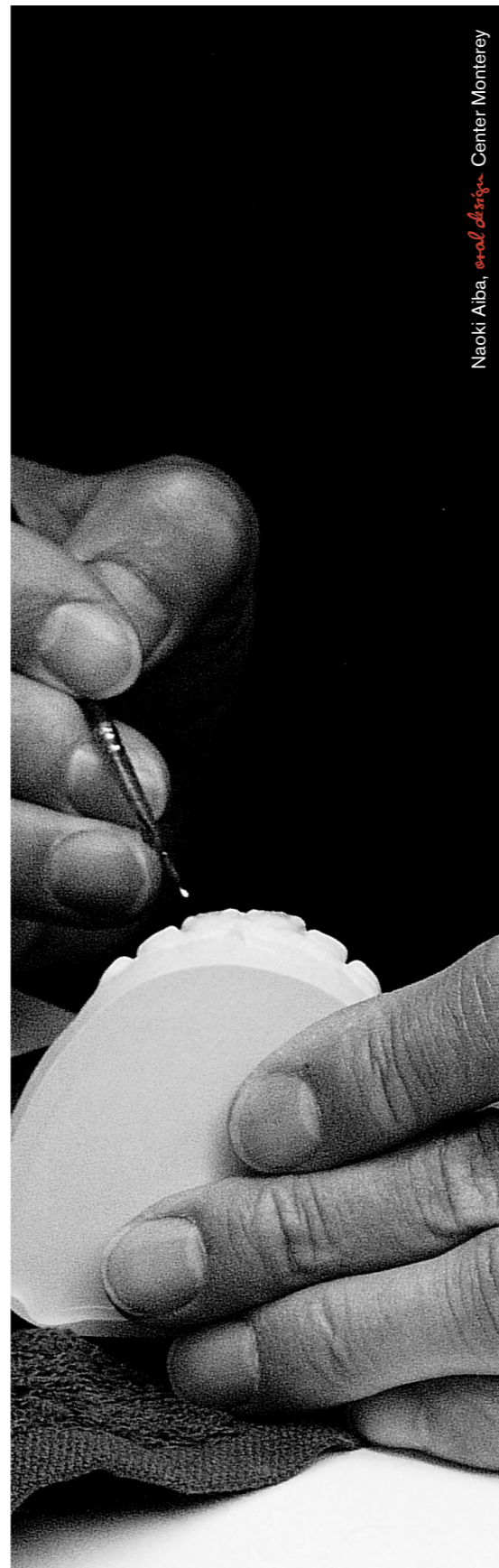

Naoki Aliba, *oral design* Center Monterey

DEKEMA. Claim.

The DEKEMA AUSTROMAT™ family is a result of a premium workmanship. The unique concept of the firing chamber, the intuitive user interface and its functionality, which sustains any worldwide comparison.

Perfect results – simple as never before.

Control your AUSTROMAT™ via the high-resolution touch screen, with your computer or your smartphone. We even provide solutions for a one-click cycle start. Don't waste your time with programing, emphasize on your core business.

**„AS SIMPLE AS POSSIBLE,
AS DETAILED AS NECESSARY!“**

Fine tuning necessary? Any time!

Up to five different input screens offer access to every single parameter, even during the program run.

Feels like home.

The user interface is consistent throughout all models. No matter which furnace you use, you immediately feel familiar and training has gone the way of the todo.

Everything is possible!

Do you prefer working with a computer mouse or a keyboard? Just connect them to the USB interfaces and get started.



DEKEMA. Manufacture.

100% Made in Germany.

All DEKEMA furnaces are hand-crafted products of our German manufactory. Every single part is either manufactured inhouse or prioritized from specialized regional suppliers.

DEKEMA. Customize.

You would like to individualize your furnace? Let your equipment reflect your personality. An individual screensaver, your logo, or your corporate color – DEKEMA customizes your AUSTROMAT™.

DEKEMA. Housing.

- » Convection cooling integrated by design without separate fan
- » Corrosion-free and lightweight aluminum housing
- » Surface texture in matt silver or matt black

DEKEMA. Lift system.

- » Vibration-free lift movement
- » Durable, maintenance-free stainless steel mechanical parts
- » Individually selectable drying position



DEKEMA. Firing chamber.

- » Designed decades ago – used for decades – refined over decades
- » Unsurpassed harmonic energy distribution
- » Each of the firing chambers are assembled at DEKEMA, with audited and weighed insulation components

DEKEMA. Fibre insulation and stone insulation.

- » DEKEMA fiber insulation – high-purity insulation, precise and dynamic
- » DEKEMA stone insulation – the traditional type of insulation, innovated by DEKEMA, unique in the market, favored by the world's most famous and best dental technicians

DEKEMA. Heating element.

- » In-house manufactured heating element coil
- » Unsurpassed in durability and longevity

DEKEMA. Thermocouple and control.

- » Platinum/platinum-rhodium thermocouple, purest quality with an accuracy of measurement far below 0,5°C
- » Best temperature behavior
- » DEKEMA silver wire test ensures only one temperature measuring point



DEKEMA. Sustainability.



Regional & energy efficient.

We focus on sustainability – from the choice of our raw materials to the technology of our dental furnaces. Our materials come from the region as far as possible, which minimises transport routes and conserves resources. At the same time, our energy-efficient technology meets the latest standards to ensure environmentally friendly operation. In this way, we combine the highest quality with responsibility for the future.

For us, sustainability is more than just a promise – it is part of our philosophy. Together, we are shaping an environmentally conscious future without compromising on quality and continuous development.



DEKEMA. Equipment.

DEKEMA trixpress™

trixpress™ – patented and worldwide unique!
The DEKEMA trixpress™ system includes ring sizes of 100 g and 200 g, adapted to the functions of the AUSTROMAT™ 654 and AUSTROMAT™ 654/™. The two sizes cover all pressing and overpressing techniques. Since the disposable placeholders can be arranged as desired, you can simultaneously process up to 20 g of porcelain and/or three different colors simultaneously during one single pressing. The use of the press ingots can be optimized by distributing the porcelain to several plungers.

DEKEMA AutoDry™

DEKEMA AutoDry™ simulates the object temperature and automatically regulates the distance between the firing object and the chamber. The vibration-free lift enables precise and accelerated drying, heating and cooling phases.

DEKEMA MPTA (Multiple Press Time Automatic)

The advancement development of the upwards-pressing propulsion of the legendary AUSTROMAT™ 3001 press-i-dent: this unique upwards-pressing propulsion, installed in the AUSTROMAT™ 654 and AUSTROMAT™ 654/™, provides perfect pressing results. Epic in precision and accuracy.

Soft Touch Lift function

The Soft Touch Lift function enables to precisely and flexible control the lift of your DEKEMA furnace via the front panel – easy and intuitive.

DEKEMA. Highlights.

DEKEMA IoT (Internet of Things)

Just register your DEKEMA furnace at DEKEMA online and profit from a secure backup of the process data and fast service to minimize downtime.

DEKEMA online service

Our DEKEMA online service is available twenty-four-seven. Register at www.dekema.com, save time and get the best service and support.

DEKEMA Connect

Connect your AUSTROMAT™ to the internet. Benefit from almost unlimited possibilities in operation, programming, control, and maintenance of your AUSTROMAT™.

DEKEMA Check

Internal test routines during the program run monitor all relevant parameters. An automatic diagnosis routine has been integrated for all substantial components to determine the service intervals.

DEKEMA online

More than 100.000 firing, pressing and sintering programs of all manufacturers of dental ceramics in our database – and more are added every day.

Load and play – it doesn't get easier than this!

myDEKEMA

The installed VNC server provides remote access to your device, only through your active clearance, in case of questions. This reduces downtime and eliminates shipping your furnace or arranging service dates on-site.

OPC and OPC UA

OPC – proven technology for communication between automation systems.
 OPC UA – an advanced, platform-independent and secure architecture that enables seamless connection of different devices and supports real-time data transmission.

Welcome to the Circle.

DEKEMA Circle

The DEKEMA Circle connects all of your DEKEMA devices. You profit from online software updates and backups, internet database connection, remote control, and the automatic transfer of project-specific firing, pressing and sintering programs.

„JUMP INTO THE DEKEMA CIRCLE – YOU WON'T STEP BACK.“

Enjoy control

You're in a meeting and want to supervise your AUSTROMAT™? With the DEKEMA Circle and your smartphone, you easily remote control your AUSTROMAT™ devices. Is the firing already finished? Did you adjust the temperature? Find all information you require, whenever you want, wherever you are.

Houston, we have a problem!

You have questions – we have the answer. With an internet connection, our support can access the furnace remotely – if you allow us to! By analyzing your QM data, we troubleshoot from any place, anywhere, anytime. We want you to be operational.





**„IT ALL BEGAN
WITH A
CERAMIC FURNACE.
TODAY
YOU RECEIVE THE
MAGNUM OPUS.“**

Dr. Stephan Miller, CEO

Be inspired by
our magna opera

AUSTR

FIRE

DMAT™

220 G2

The DEKEMA for starters redefined: faster, more powerful, more intuitive

AUSTROMAT™ 220 G2

- Stand-alone firing furnace with optional vacuum pump
- 13 kg stable
- Firing, glazing, crystallization and infiltration with and without vacuum
- APEX software with delayed vacuum switch-on point and QR codes for quick access to DEKEMA online
- 25 % faster driving speed of the lift allows instantaneous dry and closing phases
- Lift system made of high-strength aircraft aluminum for more reliable and maintenance-free lift rides
- Self-lubricating bronze guide and reinforced spring of the telescopic piston for smoother closing processes
- Optimized ventilation unit with fixed pump connection hose and integrated pressure gauge
- Plug and play: Place – Power – Perform



Applications	with vacuum	without vacuum
Fire	optional	🔥
Press	–	–
Sinter	–	–
Glaze	optional	🔥
Crystallize	optional	🔥
Infiltrate	optional	🔥

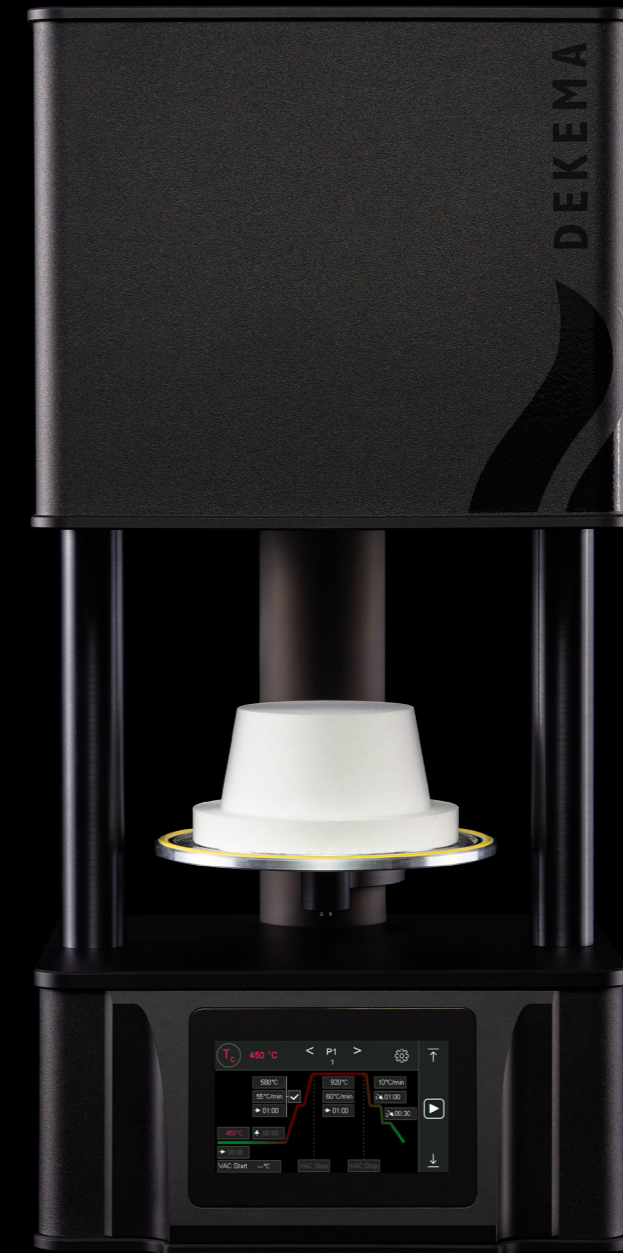

DEKEMA. Accessories. AUSTROMAT™ 220 G2

Vacuum pump (100 V, 50 – 60 Hz) Art. No. 105205
Vacuum pump (115 V, 50 – 60 Hz) Art. No. 105203
Vacuum pump (230 V, 50 – 60 Hz) Art. No. 105201

Vacuum pump, version DEKEMA 838.3 R, durable and low-maintenance, with coated, flow-optimized aluminum pump heads and special vacuum guide for highest vacuum performance.



Ventilation unit, external (100 V, 50 – 60 Hz) Art. No. 106499-01
Ventilation unit, external (115 V, 50 – 60 Hz) Art. No. 106499-01
Ventilation unit, external (230 V, 50 – 60 Hz) Art. No. 106500-01

Ventilation unit for connecting a vacuum pump to vacuum furnaces without integrated solenoid valve.



Firing table, fibre Art. No. 101733
 Firing table for use in furnaces with fiber insulation.



CALIBRITE™ fire set Art. No. 101817-01

Silver wire calibration set for exact temperature adjustment of firing furnaces, as well as of press furnaces with single-plunger press system.



CALIBRITE™ fire wire Art. No. 101821-01

15 pre-formed silver wires for precise temperature calibration of firing furnaces, as well as of press furnaces with single-plunger press system.

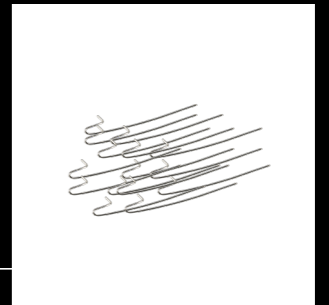

Firing tray, set Art. No. 106490

Firing tray, set of temperature-optimized honey-comb tray and 10 ceramic pins for exact positioning of firing objects.



Tweezers, DEKEMA logo Art. No. 105236

Furnace tweezers for safe handling of firing objects.



SERIES iG2

REDUCED TO THE MAXIMUM.

10,4" color touch screen display

DEKEMA Internet database furnace connection

Internet program streaming

Cloud management in the DEKEMA Circle

IoT (Internet of Things) enables intelligent networking and real-time monitoring of the furnace – ensuring 99,9% availability and seamless operation through preventive service.

Quality management: Recording of process data

USB functionalities: Transfer of firing and press programs, photos, QM files and printouts; backup and update

Ethernet interface

OPC UA interface

Online: Backup and update

AUSTR

FIRE

DMAT™

624i™ G2

AUSTROMAT™ 624i™ G2

The expert for perfect firing results.



AUSTROMAT™ 624i™ G2

- » Even heat distribution
- » Automatic control of the drying and cooling to optimize aesthetics
- » DEKEMA-specific firing chamber concept for excellent firing results in all temperature ranges
- » Thermocouple made of platinum/platinum-rhodium, purest quality with an accuracy of measurement far below 0,5°C
- » Individually selectable drying positions of the lift
- » DEKEMA AutoDry™ & AUTORITE™
- » Variable vacuum switch-on point, independent of preheating temperature
- » Access to more than 100.000 firing, pressing and sintering programs of all manufacturers of dental ceramics through DEKEMA online

DEKEMA
Colorite™
You are the artist.

CREATE YOUR



FURNACE

Applications	with vacuum	without vacuum
Fire	»	»
Press	-	-
Sinter	-	-
Glaze	»	»
Crystallize	»	»
Infiltrate	»	»



DEKEMA. Fire.

Firing is the key to flawless dentures. The ceramic is heated precisely to achieve its final shape and strength – made possible by precise process and temperature control.

Unrivalled precision

The closed insulation system and high-purity thermocouple of DEKEMA furnaces ensures constant temperatures of up to 1,500 °C with a measuring accuracy of well below 0.5° C.



DEKEMA. Accessories. AUSTROMAT™ 624i™ G2

Firing table, fibre

Art. No. 101733

Firing table for use in furnaces with fiber insulation.



CALIBRITE™ fire set

Art. No. 101817-01

Silver wire calibration set for exact temperature adjustment of firing furnaces, as well as of press furnaces with single-plunger press system.



CALIBRITE™ fire wire

Art. No. 101821-01

15 pre-formed silver wires for precise temperature calibration of firing furnaces, as well as of press furnaces with single-plunger press system.



Firing tray, set

Art. No. 106490

Firing tray, set of temperature-optimized honey-comb tray and 10 ceramic pins for exact positioning of firing objects.



Tweezers, DEKEMA logo

Art. No. 105236

Furnace tweezers for safe handling of firing objects.

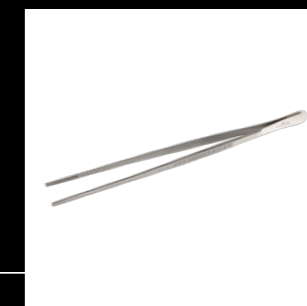

AUSTRALDRUMAT™

FIRE + PRESS

654i™ G2

AUSTROMAT™ 654i™ G2

One for all – firing and pressing in perfection.



AUSTROMAT™ 654i™ G2

- » Even heat distribution through closed chamber design
- » Automatic control of the drying and cooling to optimize aesthetics
- » Multiple Press Time Automatic for optimal pressing results
- » Besides all common ring systems, press up to 20 g with the exclusive DEKEMA trixpress™ ring system
- » Press up to 3 different shades in one go, optimizing throughput
- » Even heat distribution over all surfaces of the investment ring which provides for exceptional aesthetics
- » DEKEMA AutoDry™
- » Access to more than 100.000 firing, pressing and sintering programs of all manufacturers of dental ceramics through the DEKEMA online

DEKEMA
Colorite™
You are the artist.

CREATE YOUR



FURNACE

Applications	with vacuum	without vacuum
Fire	»	»
Press	»	»
Sinter	-	-
Glaze	»	»
Crystallize	»	»
Infiltrate	»	»



DEKEMA. Press.

Pressing shapes high-precision dentures. A blank is heated and pressed into the desired shape – for aesthetic and long-lasting results.

Unrivalled worldwide

The DEKEMA trixpress™ system combines an innovative upward pressing process with 3-plunger technology. This enables the processing of up to three colours in one step.



DEKEMA. Accessories. AUSTROMAT™ 654i™ G2

Press table, multiple plunger press system Art. No. 101726

Press table for use in press furnaces with multiple plunger press system.



Firing table, multiple-plunger press furnaces Art. No. 101734

Firing table for use in press furnaces with multiple-plunger press system.



Ceramic supports (6 pieces)

Art. No. 105488

Ceramic supports (6 pieces) for decoupled placement of press rings inside the preheating furnace.



CALIBRITE™ press set

Art. No. 101818-01

Silver wire calibration set for exact temperature adjustment of press furnaces with multiple plunger press system.



CALIBRITE™ press wire

Art. No. 101822-01

15 pre-formed silver wires for precise temperature calibration of press furnaces with multiple plunger press system.

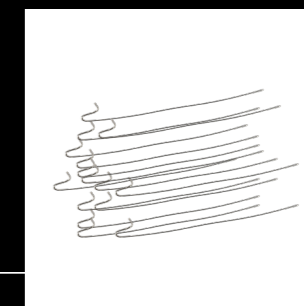

Firing tray, set

Art. No. 106490

Firing tray, set of temperature-optimized honey-comb tray and 10 ceramic pins for exact positioning of firing objects.

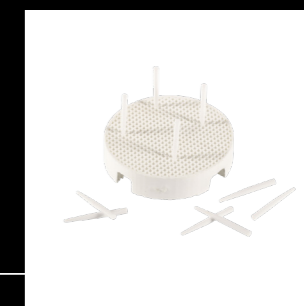

DEKEMA. Accessories. AUSTROMAT™ 654i™ G2

Tweezers, DEKEMA logo

Art. No. 105236

Furnace tweezers for safe handling of firing objects.



trixpress™ ring system, set

Art. No. 101807-01

Investment ring system trixpress™, set, consisting of base plate POM, segments for 100g and 200g investment rings, lid, 2 aluminum holding rings, Placeholder (50 pieces in blue color, Ø 13 mm) and 5 disposable press plungers.



trixpress™ press ring, 380 g segments

Art. No. 101808

Press ring for pressing over extensive restorations.



Placeholder, blue color, Ø 13 mm (50 pieces) Art. No. 101915

Placeholder (50 pieces in blue color), Ø 13 mm, combustible without residue, for trixpress™ investment ring system, for srewing press objects.



trixpress™ disposable plungers, Ø 13 mm (50 pieces)

Art. No. 105891

Disposable press plunger (50 pieces), Ø 13 mm, for single and multiple plunger pressings of all common investment materials and pressable ceramics.



BACK TO BASIC.

The Series 6.



FIRE

AUSTROMAT™ 624 **Firing in perfection.**

The AUSTROMAT 624 – the first choice for the perfect firing of ceramics. Easy and convenient to operate, it reliably guarantees outstanding results. Thanks to precise temperature control and powerful vacuum performance, you can achieve consistently high quality with impressive transparency and exact colouring. Its intelligent control system optimises the entire firing process and ensures maximum reproducibility.



FIRE + PRESS

AUSTROMAT™ 654 **The perfect all-rounder.**

The AUSTROMAT 654 is the perfect combination furnace for pressing and firing dental ceramics. With intuitive operation, precise temperature control and powerful vacuum performance, it always delivers reliable results. In addition, the AUSTROMAT 654 impresses with the highest quality and ensures exact colouring of your ceramics – for results of the highest standard. Its robust design and durable technology make it a reliable partner.

DEKEMA. Vacuum.

DEKEMA. Vacuum pump.





























- » Self-cooling aluminum heads
- » Low contamination Trenn Coat™ coating
- » Straight air flow
- » Vacuum performance down to below 20 mbar
- » High running performance with low maintenance requirements
- » Self-cleaning feature
- » Low-noise operation due to highly effective silencer



DEKEMA. Technical data.

	AUSTROMAT™ 220 G2	AUSTROMAT™ 624	AUSTROMAT™ 624i™ G2	AUSTROMAT™ 654	AUSTROMAT™ 654i™ G2
Size (WxHxD)	10,47" x 20,91" x 10,16"	15,08" x 25,71" x 13,50"	15,08" x 25,71" x 13,50"	15,08" x 25,71" x 13,50"	15,08" x 25,71" x 13,50"
Weight	28,5 lbs	38,5 lbs	42 lbs	48,5 lbs	53 lbs
Power supply	95 – 105 V/50–60 Hz or 110 – 125 V/50–60 Hz or 220 – 240 V/50–60 Hz	95 – 105 V/50–60 Hz or 110 – 125 V/50–60 Hz or 220 – 240 V/50–60 Hz	95 – 105 V/50–60 Hz or 110 – 125 V/50–60 Hz or 220 – 240 V/50–60 Hz	95 – 105 V/50–60 Hz or 110 – 125 V/50–60 Hz or 220 – 240 V/50–60 Hz	95 – 105 V/50–60 Hz or 110 – 125 V/50–60 Hz or 220 – 240 V/50–60 Hz
Maximum power supply	1.500 W	1.500 W	1.500 W	1.500 W	1.500 W
T _{max}	1.100 °C	1.200 °C	1.200 °C	1.200 °C	1.200 °C

















DEKEMA. Device equipment.

	AUSTROMAT™ 220 G2	AUSTROMAT™ 624	AUSTROMAT™ 624i™ G2	AUSTROMAT™ 654	AUSTROMAT™ 654i™ G2
Housing: Aluminum					
Corporate Design Customization	–	optional	optional	optional	optional
Touchscreen	4,3", color	7,5", color	10,4", color	7,5", color	10,4", color
USB interface / Ethernet interface	– / –	 / optional		 / optional	
Quartz glass heating element: DEKEMA specific heating element coil guided in pure quartz glass					
Fiber insulation: DEKEMA specific fiber insulation				–	–
DEKEMA stone insulation: internally fabricated, specific stone insulation	–	–	–		
DEKEMA vacuum pump	optional				
DEKEMA ventilation unit	optional	integrated	integrated	integrated	integrated
DEKEMA AutoDry™ & AUTORITE™	–				
MPTA (Multiple Press Time Automatic)	–	–	–		

DEKEMA. Software features.

	AUSTROMAT™ 220 G2	AUSTROMAT™ 624	AUSTROMAT™ 624/™ G2	AUSTROMAT™ 654	AUSTROMAT™ 654/™ G2
DEKEMA Internet database access for registered users					
DEKEMA Internet database furnace connectivity	–	optional		optional	
Internet program streaming	–	–		–	
DEKEMA Circle: Data Management in the Cloud	–	–		–	
IoT (Internet of Things) enables intelligent networking and real-time monitoring of the furnace – ensuring 99,9 % availability and seamless operation through preventive service.	–	–		–	
myDEKEMA: VNC-Viewer for remote control	–	optional		optional	
QM (quality management): Record of process files	–	optional		optional	
USB: Transferring firing programs (dds)	–				
USB: Transferring fotos (jpeg)	–				
USB: Storage of QM files (dfl)	–	optional		optional	
USB: Storage of Printouts	–				
USB: Backup/Update	–				
Internet: Backup/Update	–	optional		optional	
FTP-Server	–	optional		optional	
FTP-Client	–	optional		optional	
VNC-Server: VNC viewer for remote control of the DEKEMA furnace on the PC	–	optional		optional	
OPC: Industrial standardised connection for data exchange between different systems	–	optional		optional	
OPC UA: Secure, manufacturer-independent interface for Industry 4.0 and IoT communication	–	–	optional	–	optional
Programing languages	–	Classic, Easy, Professional	Classic, Professional	Classic, Easy, Professional, Press	Classic, Professional, Press
Language-independent program management	–	–	–	–	–

DEKEMA. Accessories.

	AUSTROMAT™ 220 G2	AUSTROMAT™ 624	AUSTROMAT™ 624/™ G2	AUSTROMAT™ 654	AUSTROMAT™ 654/™ G2
Firing table, fibre (Art. No. 101733)				–	–
Firing tray, set (Art. No. 106490)	optional	optional	optional	optional	optional
CALIBRITE™ fire set (Art. No. 101817-01)	optional			–	–
Firing table, multiple-plunger press furnaces (Art. No. 101734)	–	–	–		
Press table, multiple plunger press system (Art. No. 101726)	–	–	–		
Ceramic supports, 6 pieces (Art. No. 105488)	–	–	–	optional	optional
CALIBRITE™ press set (Art. No. 101818-01)	–	–	–		
trixpress™ ring system, set (Art. No. 101807-01)	–	–	–	optional	optional
trixpress™ press ring, 380 g segments (Art. No. 101808)	–	–	–	optional	optional
trixpress™ disposable plungers, Ø 13 mm, 50 pieces (Art. No. 105891)	–	–	–	optional	optional
Placeholder, blue color, Ø 13 mm, 50 pieces (Art. No. 101915)	–	–	–	optional	optional
Tweezers, DEKEMA logo (Art. No. 105236)	optional				
Software Package for AUSTROMAT™ 624 or AUSTROMAT™ 654 (Art. No. 101933)	–	optional		optional	



DEKEMA

Der Ofen.™

DEKEMA Dental-Keramiköfen GmbH

Industriestraße 22 • 83395 Freilassing • Germany

☎ +49-8654-46390 ✉ +49-8654-66195

info@dekema.com • www.dekema.com

